



Miramar, FL
Phone: 954-499-5400
Fax: 954-499-5454
www.amprobe.com

USER MANUAL

A UNIQUE CLAMP-ON MULTIMETER

MODEL: ACD-330T



LIMITED WARRANTY

Congratulations! Your new instrument has been quality crafted according to quality standards and contains quality components and workmanship. It has been inspected for proper operation of all of its functions and tested by qualified factory technicians according to the long-established standards of our company.

Your instrument has a limited warranty against defective materials and/or workmanship for one year from the date of purchase provided that, in the opinion of the factory, the instrument has not been tampered with or taken apart.

Should your instrument fail due to defective materials, and/or workmanship during this one year period, a no charge repair or replacement will be made to the original purchaser. Please have your dated bill of sale, which must identify the instrument model number and serial number and call the number listed below:

Repair Department

Phone: 954-499-5400 / 800-327-5060

Fax: 954-499-5454

Website: www.amprobe.com

**Please obtain an RMA number before
returning product for repair.**

*Outside the U.S.A. the local representative will assist you.
Above limited warranty covers repair and replacement of
instrument only and no other obligation is stated or implied.*

**ACDC-3000
TABLE OF CONTENTS**

SAFETY INFORMATION	1
• INTRODUCTION	2
USING THE METER SAFELY	4
LCD DISPLAY ILLUSTRATION	5
GETTING ACQUAINTED WITH YOUR METER	6
• ALIGNMENT MARKS	6
• ROTARY SWITCH	6
• INPUT TERMINAL	7
• PUSH BUTTONS	8
PUSH-BUTTON OPERATIONS	9
POWER-ON OPTIONS	11
SPECIAL FUNCTIONS INSTRUCTION	11
• Dynamic Recording	12
• Data Hold	12
• Zero (Relative)	14
• Analog Bargraph	15
• Auto Power Off and Sleep Mode	16
• Disable Auto Power Off	17
• Demonstrate Annunciator	17
• Continuity Function For Ohms Measurement	17
• 1 ms Peak Hold	18
• Backlit LCD for easy reading in the dark	19
HOW TO OPERATE	19
• AC CURRENT MEASUREMENT	19
• DISTRIBUTION TRANSFORMERS MEASUREMENT	21
• ADJUSTABLE SPEED MOTOR CONTROLLERS	23
• AC MOTOR CURRENT MEASUREMENT	25
• AC VOLTAGE MEASUREMENT	27
• RESISTANCE/ CONTINUITY MEASUREMENT	28
• DIODE CHECK	29
GENERAL SPECIFICATIONS	30
ACCESSORIES AND REPLACEMENT PARTS	30
ELECTRICAL SPECIFICATIONS	31
CURRENT HARMONICS THEORY	33
• TRUE RMS MEASUREMENTS	34
• WAVEFORM COMPARISON	35
MAINTENANCE	37
• SERVICE	37
• BATTERY REPLACEMENT	37
• CLEANING	37

SAFETY INFORMATION

SAFETY INFORMATION

To ensure that you use the meter safely, follow the safety guidelines listed below.

- This meter is for indoor use, altitude up to 2000m..
- Avoid working alone. Take precautions when working around moving parts.
- Use extreme caution when working around bare conductors or high voltage. Accidental contact with the conductor could result in electric shock.
- Use the meter only as specified in this manual. Otherwise, the protection provided by the meter may be impaired.
- Never measure current while the test leads are inserted into the input terminals.
- Do not use the meter if it looks damaged.
- Inspect the leads for damaged insulation or exposed metal. Check test leads continuity. Replace damaged leads.
- Disconnect the power and discharge all high-voltage capacitors before testing in the resistance, continuity, and diode function.
- Use caution when working above 60VDC or 30VAC RMS. Such voltages pose a shock hazard.
- When making measurements, keep your fingers behind the finger guards, on the probe.
- Set the proper function and range before attaching the meter to circuit. To avoid damaging the meter disconnect the test leads from test points before changing functions.
- Read this operation manual completely before using the meter and follow all safety instructions.

- The meter is safety-certified in compliance with UL311-1, C22.2 NO.1010.1-92 and EN61010 (IEC1010-1, IEC 1010-2-031, IEC 1010-2-032). Installation Category II 1000V or Installation Category III 600V. In order to maintain its insulation properties, please be sure to use with ULListed Category II 1000V or Category III 600V probes.

- Installation Category (CAT) II is an environment with smaller transient over voltage than Installation Category III.

- CE requirement: Under the influence of R.F. field according to standard, the supplied test leads will pick up induced noise. To have better shielding effect, a short test lead should be used. The following tests are required in order to conform to CE:
 1. IEC 801-2:ESD (electro static discharge) test.
 2. IEC 801-3:RFI (Radio Frequency Interference) test.
Condition: 27 ~500MHz, signal intensity is 3 volts per meter.
 3. IEC 801-4:EFT(electro fast transient) test.
 4. EN 55011: EMI (electro magnetic interference) test.

A UNIQUE CLAMP-ON MULTIMETER

□ INTRODUCTION

Measuring current accurately is a difficult job in today's industrial plants and commercial buildings. An increasing number of personal computers, adjustable speed motor drives, and other types electronic equipment come on-line every day. These, devices draw current in short pulses, and are referred to as non-linear loads.

Non-linear loads draw high peak -currents, causing harmonics in the load current. This may result in unexplained circuit breaker tripping, or dangerous overheating of neutral conductors and transformers. Currents containing harmonics, can only be accurately measured with a true-rms meter or Clamp meter.

This CLAMP-ON MULTIMETER is shown in **Figure 1**. This meter has many functions which, are shown below:

- **TRUE RMS measurement for non-linear and traditional loads.**
- **1 ms Peak Hold feature to capture glitch or in-rush current.**
- **Dual Display Mode: Current vs Frequency or Voltage vs Frequency.**
- **Diode measurement.**
- **Dynamic Recording helps to record the variation of tests.**
- **Hand Guard for prevention of accidental contact with conductors.**
- **Carrying case with shoulder strap.**
- **Data Hold to freeze displayed digital value.**
- **Relative (zero) function.**
- **Auto and Manual Ranging.**
- **Backlit display for easy reading in dark places.**



Figure 1. A Unique Clamp-ON Multimeter

USING THE METER SAFELY

WARNING

Read "SAFETYINFORMATION" before using the meter.

NOTE

Some typical tests are provided in this manual. These tests are designed to help you understand how to use the Meter. Consult original manufacturer service manual for the test procedures that apply to your particular piece of equipment.

Your Clamp-on multimeter is a hand-held, battery-operated instrument for testing and troubleshooting electrical and electronic systems. If the meter is damaged or something is missing, contact the place of purchase immediately.

A **WARNING** identifies conditions and actions that pose hazard(s) to the user; a **CAUTION** identifies conditions and actions that may damage the Meter. International electrical symbols used are explained in **Table 1**.







	AC ~ Alternating Current
	DC ~ Direct Current
	AC and DC ~ Alternating and Direct Current
	Ground
	Double Insulation
	See Explanation in the Manual

Table 1. International Electrical Symbols

FRENCH WARNING

This meter has a warning on the bottom chassis case that needs to be followed prior to opening the case. We have transferred this to French translation as listed below:

**ATTENTION
POUR EVITER UN CHOC ELECTRIQUE,
ENLEVER LES CORDONS D'ESSAI AVANT
D'OUVRIER LE BOITIER.**

**NE PAS UTILISER LORSQUE LE BOITIER
EST OUVERT**

LCD DISPLAY ILLUSTRATION



- 1) - : Negative Polarity Annunciator
- 2) @OFF : Auto Power Off Enabled Annunciator
- 3)  : Low Battery Annunciator
- 4) DC : Direct Voltage Annunciator
- 5) AC : Alternating Current or Voltage Annunciator
- 6) AUTO : Indicates AUTO range mode Annunciator
- 7) D : Data hold annunciator
- 8) D MAX : Peak Hold annunciator (1 mS response)
- 9) MAX AVG MIN : Dynamic recording mode, Present Reading
- 10) MAX : Maximum reading
- 11) MIN : Minimum reading
- 12) AVG : Average reading
- 13) -))) : Continuity function annunciator
- 14)  : Diode Measurement
- 15) kHz : Unit of frequency
- 16) V : Unit of voltage measurement
- 17) A : Unit of Current measurement
- 18) k : Unit of resistance (ohm) measurement
- 19) δ : Zero (delta) mode annunciator
- 20) 8.8.8.8 : Digital display for A, V, δ , and diode
- 21)  : Analog bar-graph annunciator
- 22) - 8.8.8.8 : Digital display for frequency



Figure 2. LCD Display

Getting Acquainted With Your Meter

□ ALIGNMENT MARKS

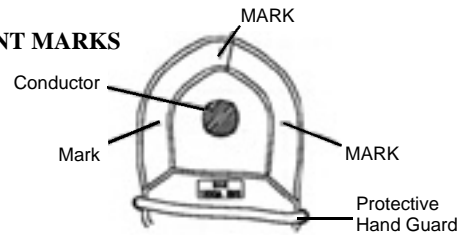

Figure 3. Alignment Marks

In order to meet the meter accuracy specifications when making a current measurement, the conductor must be inside the jaws and centered within the indicated marks as much as possible. (see Figure 3)

□ Rotary Switch

To turn the meter on and select a function, turn the rotary switch (**Figure 4**) to a switch setting. The whole display lights for one second.

Then the meter is ready for use. (If you press and hold down any pushbutton while turning the meter from OFF to ON, the display remains, lit until the pushbutton is released.)

- 1) Power Off Position
- 2) AC Current measurements.
- 3) AC or DC Voltage. Default is AC voltage.
- 4) Ohms and Continuity. The continuity buzzer sounds when test value that is displayed is below 100 counts.
- 5) Diode and Audible Continuity measurements.

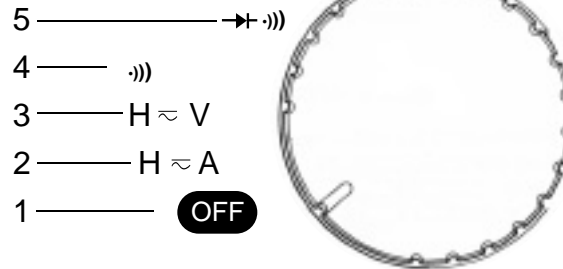

Figure 4. Rotary Switch

□ INPUT TERMINAL

WARNING

To avoid damaging the meter, do not exceed input limits shown below in Table 1:



ROTARY SWITCH FUNCTION	INPUT TERMINAL	INPUTLIMIT
AC 400 ~ 1000V(CAT II)	V-  & COM	CAT II
AC 400 ~ 600V (CAT III)		1000VAC/ 1000VDC
DC 400 ~1000V(CAT II)		CAT III
DC 400 ~600V (CAT III)		600V
AC 400 ~ 1000A	Clamp Jaw	1000ARMS
OHM (Ω)		
DIODE (\rightarrow ))))	V-  & COM	600VRMS

Table 1. Input limit Specifications

The meter has two input terminals (**Figure 5**) that are protected against overloads to the limits shown in the specifications.

- 1) Common terminal for all measurements (except current).
- 2) Volts, Ohms, Diode, measurements.

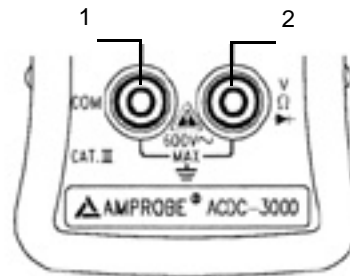

Figure 5. Input Terminal



Figure 6. Push Buttons

Push-button Operations

The operation of the push-buttons are outlined below. When a button is pushed, an annunciator lights, and the unit beeps. Turning the rotary switch to another switch setting resets all push buttons to their default states. The pushbuttons are shown in **Figure 6** (Page 08).

1. Shift / Peak

- This push-button is used for selecting the measurement of either an Alternating or Direct source, or for selecting the PEAK hold function.
- Press this button momentarily to toggle DC and AC voltage test.
- To select PEAK hold, press and hold this button until the display shows " DH MAX" and indicates the PEAK hold mode.

2. Hold : DATA HOLD or Refresh Data Hold

- The data HOLD function allows operator to freeze the displayed digital value while the analog bargraph continues to display the present reading.
- Press this button momentarily to toggle DH on or off. The display shows "DH" to indicate the hold function.
- If you select " Refresh Data Hold " by Power-ON Options, the reading is updated to the display automatically when the reading changes. The beeper sounds a tone to remind user, that an update has occurred.
- Press this button momentarily to toggle DH on or off.

3. MAX a MIN : Dynamic Recording

- To enter or exit dynamic recording mode, press and hold this button to toggle recording mode on or off.
- Records maximum, minimum, and calculates true average.
- Press this button momentarily to cycle through maximum, minimum, average and present (MAX AVG MIN) readings.
- The beeper sounds when a new maximum, or minimum value is recorded.

4. Zero /*

- Push this button momentarily to zero the residual current. Note: Allow the meter to stabilize before zeroing the display. The " A " will also be displayed.
- Press this button for more than 1 second to toggle Backlight ON or OFF. Backlight turns off automatically after 30 seconds.

5. •))) / Hz ○ : Continuity, Frequency

- In the position, press this button momentarily to toggle "•)))" continuity ON/OFF. The continuity buzzer sounds when test value is below 100 counts (10.0 on auto range). Pushing this button for more than 1 second will exit the continuity function and return to the auto-ranging ohm measurement.
- Press to restart 1 ms PEAK hold test after entering PEAK mode.
- In the voltage and Current tests, push this button momentarily to enter dual display mode. The small digits will indicate frequency reading. The frequency test always auto range measuring.

6. AUTO / RANGE ○ :

- In auto-range press this button momentarily to select manual range and turn off the "AUTO" annunciator.
- In manual range, press this button momentarily to step up 1 range at one time, press this button for more than 1 second to enter auto-range.
- In auto-range, the " AUTO " annunciator is lit and the meter will select an appropriate range for measurement being made. If a reading is greater than maximum available range, " OL"(overload) is displayed on the screen. The meter selects a lower range when reading is less than about 9% of full scale.

POWER-ON OPTIONS

□ SELECTING POWER -ON OPTIONS

Some options can be selected only when you turn the meter on. These power-on options are listed in Table 2 To select power-on options, press and hold down pushdown while turning the rotary switch to any ON position. Power-on options remain selected until the meter is turned off.

PUSH BUTTON	OPTION DESCRIPTION
DH ○ MAX • MIN	<p>Demonstrate Annunciators To demonstrate the annunciators, Full annunciators are displayed. Press any buttons momentarily to exit demonstrate mode.</p> <p>Disable auto-poweroff In general, the auto-power off function turns the meter off if neither rotary switch nor push button is activated for 15 minutes. You can disable auto-power off function by this option. When auto-power off is disabled the meter will stay on continuously. Auto-power off is auto disable in Dynamic Recording. Enable "Refresh Data Hold".</p>
Hz ○ •))	Turns off all beeper functions.

Table 2. Power-On Options

SPECIAL FUNCTIONS INSTRUCTIONS

This clamp-on multimeter provides the operator with various functions including:

- Dynamic Recording
- Data Hold
- Zero(Relative)
- Analog Bargraph
- Auto Power Off and Sleep Mode
- Disable Auto Power Off
- Demonstrate Annunciator of Display
- Continuity Function For Ohms Measurement
- 1 ms Peak Hold
- Backlit LCD for easy reading in the dark

□ DYNAMIC RECORDING

The dynamic recording mode can be used to catch intermittent and turn on or turn off surges, verify performance, measure while you are away, or take readings while you are operating the equipment under test and can not watch the meter. Refer to Figure 7.

The average reading is useful for smoothing out unstable or changing inputs, estimating the percent of time a circuit is operational, or verifying circuit performance.

The operational procedures are described below:

- 1) Press and hold the "MAX * MIN" pushbutton to toggle recording mode on or off. The dynamic recording mode is indicated when the MAX AVG MIN annunciator turns on. The present value is stored to memories of maximum, minimum and average.
- 2) Press this button momentarily to cycle through maximum, minimum, average and present readings. The MAX, MIN, AVG annunciator turns on respectively to indicate what value is being displayed. See Figure 3)
- 3) The beeper sounds when a new maximum or minimum value is recorded.
- 4) If an overload is recorded the averaging function is stopped. An average value becomes " OL"(overload).
- 5) In dynamic recording, the auto power off feature is disabled and the " Off" turns off.
- 6) By selecting dynamic recording in the auto range, the meter will record the value of MAX, MIN or AVG for different ranges.
- 7) The record speed of dynamic recording is about 100 milli-seconds (0.1 second).
- 8) The average value is the true average of all measured values taken since the recording mode was entered.

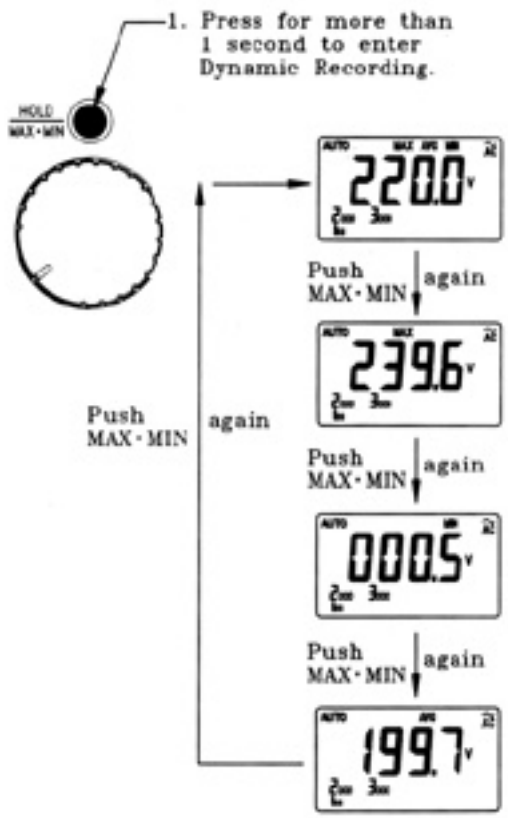

Figure 7. Display of Dynamic Recording

□ DATA HOLD

The data HOLD function allows operator to freeze the displayed digital value while the analog bargraph displays present readings. Press "DW HOLD" button to enter the data HOLD mode, and the "D" annunciator is displayed.

Press the button again to exit. The present reading is now shown.



Figure 8. Data Hold Operation

□ ZERO (RELATIVE)

The ZERO (relative) function subtracts a stored value from the present measurement and displays the result.

1) Press the ZERO button momentarily to set the relative mode. This sets the display to zero and stores the present reading as a reference value. The "Δ" annunciator will also be displayed. Press this button again to exit the relative mode.

2) The ZERO (relative) mode can be set in both the autorange or manual range mode. The relative mode can't be set when an overload has occurred.

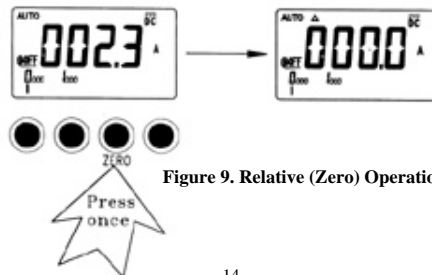

Figure 9. Relative (Zero) Operation.

□ ANALOG BARGRAPH

The analog bargraph display provides a 12-segment analog reading representation. The unit of the bargraph is 100 counts/bar.



Figure 10. Analog Bargraph.

□ AUTO POWER OFF AND SLEEP MODE

There are two modes for power saving:

- 1) The instrument will enter the "sleep" mode within 15 minutes, unless:
 - 1-1. Any push buttons have been pressed
 - 1-2. The rotary switch has been changed to another function
 - 1-3. The unit has been set to Dynamic recording mode
 - 1-4. The unit has been set to 1 ms PEAK hold mode.
 - 1-5. The auto power off has been disabled with powerup option
- 2) In the sleep mode, the LCD will display a blinking "@OFF, . . ." annunciator.
 - 2-1. To wake-up sleep mode, press any push button for 0.5 sec or rotate rotary switch.
 - 2-2. Without wake-up, after 15 minutes, the meter will automatically shut off completely.
- 3) You must turn the rotary switch to the OFF position, then turn it back to a function to activate the meter after an auto power off.

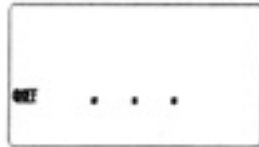

Figure 11. Sleep Mode

□ DISABLE AUTO POWER OFF

When the meter is to be used for long periods of time you may want to disable the auto power off. Once the auto power off function is disabled, the meter will stay on continuously. The meter is shut off by turning the rotary switch to the OFF position.

To activate this function, press and hold the "HOLD/MAX * MIN" button and turn the rotary switch from the OFF position to the desired function. When all annunciators are displayed, press any button momentarily to exit demonstrate mode, and the "Off" annunciator will be off.

□ DEMONSTRATE ANNUNCIATOR

To demonstrate the annunciators, press "HOLDIMAX * MIN" button and turn on the meter simultaneously. All annunciators will be displayed. Press any button to exit demonstrate mode. Auto power off will be disabled.



Figure 12. Demonstrate Annunciator

□ CONTINUITYFUNCTION FOR OHMS MEASUREMENT

To enable the continuity function, set the meter to the range. Press -))) button momentarily to toggle the CONTINUITYfunction ON/OFF. The continuity range is 0400-0 and the beeper will sound if the resistance is less than 10.0 Ω. If another range is selected, the unit will beep if the value displayed is less than 100 counts. Momentarily pushing this button again will toggle the beeper and annunciator on or off.

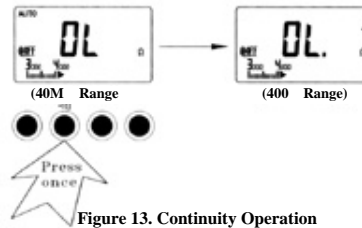

Figure 13. Continuity Operation

□ 1 ms PEAK HOLD

You can use this Meter to analyze components such as power distribution transformers and power factor correction capacitors. The additional features allow the measurement of the half-cycle peak current by using the 1 ms peak hold feature. This allows the determination of the crest factor:

$$\text{Crest factor} = \frac{\text{Peak value}}{\text{True rms value}}$$

- 1) Press PEAK button for more than 1 second to toggle 1 ms peak hold mode ON/OFF.
- 2) Press PEAK button momentarily to select PEAK+ measurement after entering the peak mode. The display shows "DH MAX" to indicate the PEAK +. See Figure 14.
- 3) If the reading is "OL", then you can push RANGE button momentarily to change measuring range and restart the PEAK+ measurement after setting the peak mode.
- 4) Press .))) button to re-set the 1 ms peak hold again after setting peak mode.

Note: A crest factor of 1.4 indicates a sinusoidal waveform.

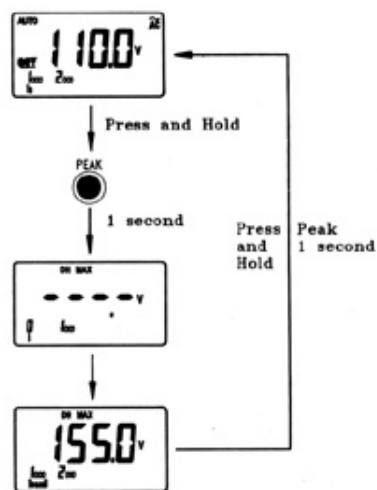

Figure 14. 1 ms Peak Hold Display

□ BACKLITDISPLAY FOR EASYREADING IN THE DARK

Press * button for more than 1 second to toggle backlight ON/OFF. Backlight turns off automatically after 30 seconds. To disable backlight(off automatically after 30 seconds), use POWER-ON option (see page 17).

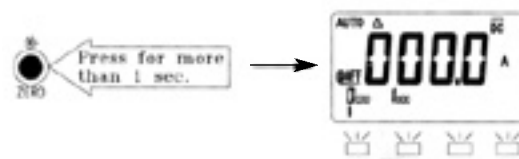

Figure 15. Backlit Display.

□ AC CURRENTMEASUREMENT

WARNING: MAKE CERTAIN THAT ALL TEST LEADS ARE DISCONNECTED FROM THE METER TERMINALS.

- 1) Set the rotary switch to " A ".
- 2) Open the meter jaws and clamp around a single conductor. The most accurate reading will be obtained by keeping the conductor aligned with the centering marks on the jaws. Make sure that the jaws are fully closed.
- 3) Read the display.

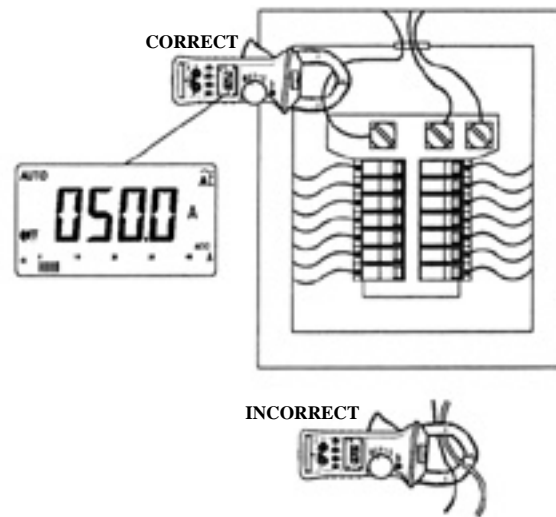

Figure 16. Measuring In Rush Current.

DISTRIBUTION TRANSFORMER MEASUREMENT

You can measure current, phase imbalance between phases, and true RMS neutral current. True RMS measurement yields the effective value.

- 1) Set the rotary switch to " A ".
- 2) Clamp around a phase wire of the transformer. Be sure the jaws are completely closed or measurement will not be accurate.
- 3) Observe the display for true RMS current.
- 4) Repeat your measurement for each phase to determine balance. Imbalanced phases and/or harmonics can cause neutral currents.
- 5) Observe the display for true RMS current reading. If the phases are balance, any significant current flow on the neutral may indicate the presence of harmonic currents.
- 6) Press the HOLD/ MAX • MIN button to freeze the digital display.
- 7) Press and hold the SHIFT button (>1sec) to enter the PEAK mode (DH MAX displayed). Measure the halfcycle PEAK current. Divide first reading into the second reading to determine crest factor, A crest factor other than 1.4 is an indication of harmonic current.
- 8) Press and hold the SHIFTbutton (>1sec) to exit the PEAK mode.
- 9) Press and hold the HOLD/ MAX • MIN (>1sec) to enter dynamic recording mode. Momentarily press HOLD/ MAX • MIN button to review recorded maximum, minimum, and average values.
- 10) Press and hold the HOLD/ MAX • MIN button (>1sec) to exit recording.

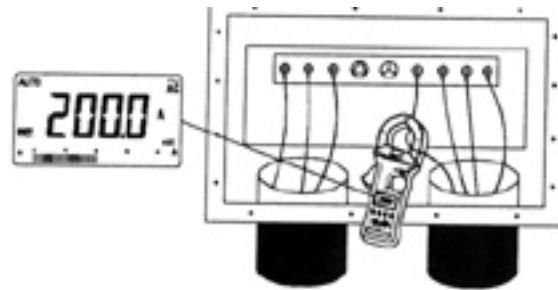

Figure 17. Measuring AC Current.

ADJUSTABLE SPEED MOTOR CONTROLLERS

You can measure input current, output current and frequency of adjustable speed motor controllers. The output current frequency is used to calculate the rotating speed of the motor, while input current frequency is used to measure the frequency of the power line. The frequency of the output current is important because the voltage frequency is often meaningless for the calculations of motor controller speed.

- 1) Set the rotary switch to " A ".
- 2) Clamp around an input or output phase (as required), and run motor at desired speed. Be sure the clamp jaws are securely closed, or measurements will not be accurate.
- 3) Observe the display for true RMS current.
- 4) Measure an output phase of the motor controller and press Hz button momentarily to enter dual display mode. Then you will see the frequency reading be shown on small digits. Nominal motor speed is calculated formula is shown below:

$$\text{RPM} = 120 \text{ F/P}$$

F: measured frequency.

P: number of pairs of motor poles

- 5) Press the MAX • MIN button for more than 1 second to record readings. To view readings, momentarily press MAX • MIN button.
- 6) Press the MAX • MIN button for more than 1 second to exit recording.

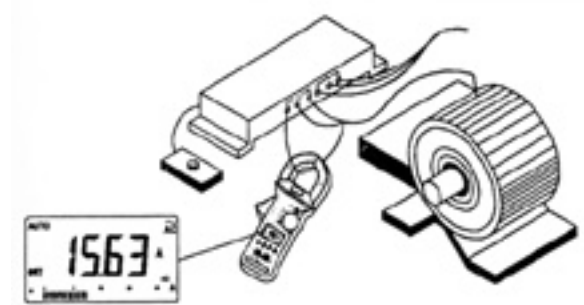

Figure 18. Measuring Input/Output AC Current of Controller.

AC MOTOR CURRENT MEASUREMENT

You can measure starting (inrush) current, running current, and current imbalance in AC Motor circuits. Inrush current is typically 6-8 times the value of running current, depending on the motor type.

- 1) Set the rotary switch to " A ".
- 2) Press and hold the PEAK button (>1sec) to enter 1 ms PEAK hold mode.
- 3) Clamp around a motor phase conductor. Be sure the clamp jaws are completely closed, or measurement will not be accurate.
- 4) Press ZERO button to set the display to zero.
- 5) Turn the motor on. When the motor gets to the desired speed, observe the display for inrush current reading.
- 6) If the reading is " OL", you can push the RANGE button momentarily to change measuring range. Turn off the motor.
- 7) Repeat your measurement from step 2 through 6 for each phase. A voltage imbalance or a shorted motor winding may cause imbalanced current.

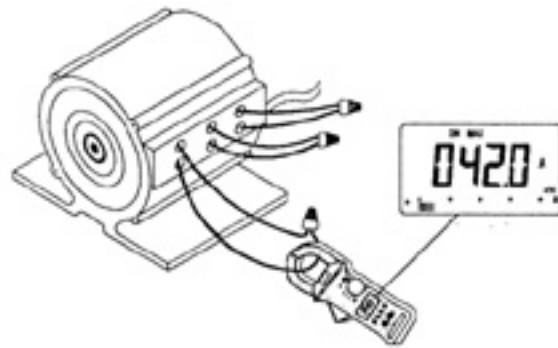

Figure 19. Measuring AC Motor Current.

□ AC VOLTAGE MEASUREMENT

- 1) Set the rotary switch to “V”.
- 2) Insert the black test lead to “COM” terminal and red test lead to “V” terminal.
- 3) Touch the probes to the test points and read the displayed AC voltage.

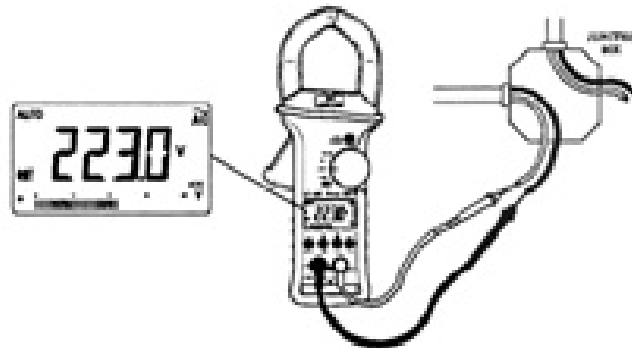

Figure 20. Measuring Voltage.

□ RESISTANCE / CONTINUITY MEASUREMENT

CAUTION: Make sure that power is removed and all capacitors have been discharged before measuring.

- 1) Set the rotary switch to "Ω". OL is displayed.
- 2) Insert the black test lead to "COM" terminal and red test lead to "V- Ω" terminal.
- 3) Short the test leads together and momentarily press the ZERO button to subtract test lead resistance from measurement.
- 4) Touch the test leads to the circuit (Fuse Cartridge or other) and read resistance value in the display.
- 5) Press "HOLD" button momentarily to enter continuity function if desired.
- 6) Repeat steps 3 and 4. The beeper sounds if continuity reading is less than 10.0 Ω.
- 7) OL (overload) is displayed if the resistance across the input terminals is greater than the full-scale rating on the range setting of the instrument. Be sure that the contact between the probes and the circuit is clean. Dirt, oil, paint, rust or other foreign matter can seriously effect resistance measurements.

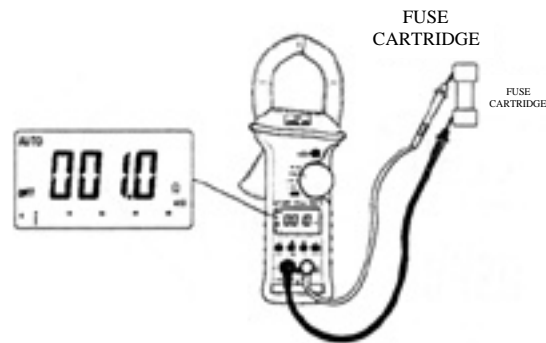

Figure 21. Measuring Resistance and Continuity.

□ DIODE CHECK

A good diode allows current to flow in one direction only. To test a diode, turn the power off, remove the diode from the circuit, and proceed as follows:

- 1) Set the rotary switch to "→" position.
- 2) Connect the black test lead to "COM" terminal and red test lead to "V-" terminal.
- 3) Touch the red lead to the positive side of the diode and the black lead to the negative side. The meter can display diode voltage drops to approximately 2.5 V. A typical voltage drop is 0.3~0.8 V, and the meter will sound a beep to remind user.
- 4) Reverse the probes and measure the voltage across the diode again. If the diode is:
 - Good : "OL" is displayed.
 - Shorted : Near 0 V drop is displayed in both directions, and the beeper sounds continuously.
 - Open : "OL" is displayed in both directions.
- 5) Repeat step 3 and 4 for other diodes.

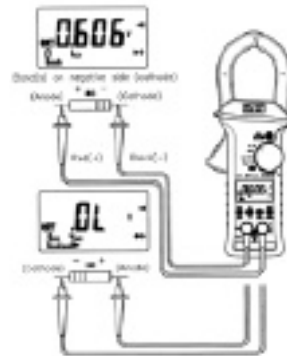

Figure 22. Diode Check.

GENERAL SPECIFICATIONS

Display: Fully annunciating 4-digit liquid crystal display (LCD) with maximum reading of 4,000 count. Dual display in Temperature mode. 12 segments analog bar graph. Automatic polarity indication.

Functions: DCV, ACV, DCA, ACA, OHM, Continuity, Frequency and Diode tests.

Measuring rate: 3.3 times per second for V, A, Ohm and Diode tests.
1 ~ 2 seconds per time for frequency test.

Low battery indicator: The "E3" appears when the battery voltage drops below 7V (approx.).

Operating temperature: 0° C to 50° C (32° F to 122° F), 0 - 80% R.H.

Storage temperature: -20°C to 60°C (-4°F to 140°F), 0 - 80% R.H. with BATTERY REMOVED.

Temperature coefficient: 0.12 % / °C (from 0°C to 18°C or 28°C to 50°C).
0.067 % / °F (from 32°F to 64.4°F or 82.4°F to 122°F)

Powersupply: Single standard NEDA1604, JIS006P, IEC6F22 carbon zinc or alkaline type 9V battery.

MAX. Jaw Opening: To Accommodate Circuit Cables 2.04" (52 mm) diameter.

Dimension: 32 (H) x 64 (W) x 273 (L) mm / 1.26" (H) x 2.52" (W) x 10.74" (L)

Weight: 860 grams with battery included. (1.9 lbs with battery included.)

Standard Accessories: Test leads (pair), Manual, Battery and Carrying case.

Safety: Designed and manufactured to conform to UL3111-1, C22.2 NO. 1010.1-92 and EN61010 (IEC1010-1, IEC1010-2-031, IEC-1010-2-032) Installation Category (Overvoltage Category) II 1000V or Installation Category III 600V, Pollution Degree 2 environment.

Note: Meter has been submitted for approval to above standard at the time of printing of this manual. Product will be marked accordingly upon approval.

ACDC-300 ACCESSORIES AND REPLACEMENTS PARTS

Amprobe P/N	Description
MTL-90B	Safety Test Leads (included)
CC-ACDC	Carrying Case (included)
MN-1604	9 Volt Alkaline Battery (included)
978762	Instruction Manual (included)

ELECTRICALSPECIFICATIONS

Accuracy is given as $\pm\%$ of reading + number of least significant digits at 23° C \pm 5° C, with relative humidity Less than 80% R.H.

DC VOLTAGE

Range	Resolution	Accuracy	Overload Protection
400V	0.1V	$\pm(1\%rdg+3dgt)$	1000V
1000V	1V		AC RMS

• Input Impedence 10M

AC VOLTAGE (TRUE RMS: From 10% to 100% of range.)

Range	Resolution	Accuracy	Overload Protection
400V	0.1V	45Hz~400Hz	1000V AC RMS
1000V	1V	$\pm(1.5\%rdg+3dgt)$	

• Input Impedence 10M // less than 100pF

Crest factor: <3:1

AC VOLTAGE (1 ms PEAK HOLD.)

Specified accuracy +/- 40 digits for changes > 1 ms in duration.

Range	Resolution	Accuracy	Overload Protection
400V	0.1V	$\pm(1.5\%rdg+43dgt)$	1000V
1000V	1V		AC RMS

• Input Impedence 10M

AC CURRENT(TRUE RMS: From 10% to 100% of range.)

Range	Resolution	Accuracy			Maximum Overload
		45~ 65 Hz	65~ 400 Hz	400~ 1k Hz	
400 A	0.1A	$\pm(1.2\%+5dgt)$	$\pm(2.0\%+5dgt)$	$\pm(4.0\%+5dgt)$	1000 A RMS
400 ~ 700 A	1A	$\pm(1.5\%+5dgt)$	$\pm(3.0\%+5dgt)$	$\pm(5.0\%+5dgt)$	
700 ~ 1000 A	1A	$\pm(2.5\%+5dgt)$			

• This unit has a crest factor up to 3 on symmetric waveforms.

WARNING:

The measuring duty cycle should not exceed the following limits.

0 ~ 600 A RMS	Continuous
600 ~ 700 A RMS	10 minutes ON, 10 minutes OFF
700 ~ 1000 A RMS	5 minutes ON, 20 minutes OFF

CURRENT (1ms PEAK HOLD)

Specified accuracy +/-40 digits for changes > 1 ms in duration.

Range	Resolution	Accuracy
400A	0.1A	$\pm(2\%rdg+43dgt)$
1000A	1A	$\pm(2\%rdg+43dgt)$

FREQUENCY(AC coupling)

Range	Resolution	Accuracy	Minimum Input Frequency
100Hz	0.01Hz	$\pm(0.2\%rdg+4dgt)$	10Hz
1kHz	0.1Hz		

• Overload protection: 1000Vrms AC;< 1000000 VxHz

FREQUENCYCOUNTERSENSITIVITY	
INPUTRANGE	MINIMUM SENSITIVITY (RMSSINEWAVE)
(Maximum input for specified accuracy =10 x range or1000V)	40 Hz-2 kHz
400A	3A
1000A	30A
400V	3V
1000V	30V

RESISTANCE

Range	Resolution	Accuracy	Max Test Voltage	Overload Protection
400	0.1	$\pm(1\%rdg+3dgt)$	3.3V	600Vrms
4k	1		1.25V	

• Instant continuity mode, built-in buzzer sounds when resistance is less than 10.0 .

DIODECHECK

Range	Resolution	Accuracy	Test Current	Test Voltage
Diode	1mV	$\pm(1.0\%rdg+2dgt)$	approx. 1.65 mA	<3.3V

• Overload protection: 600VRMS

AUDIBLE CONTINUITYTEST

Range	Resolution	Accuracy	Test Current	Test Voltage
Diode	1mV	built-in buzzer sounds when reading is below approx. 100mV	approx. 1.65 mA	<3.3V

• Overload protection: 600VRMS

CURRENT HARMONICS THEORY

True-RMS current is very important because it directly relates to the amount of heat dissipated in wiring, transformers, and loads. Most clamp-on meters already in the field measure average current, not true RMS current, even if this average value is displayed on a scale calibrated in RMS. These average-sensing meters are accurate only for sinusoidal signals.

All current signals are distorted in some way. The most common is harmonic distortion caused by non-linear loads such as office machines, medical equipment, personal computers, or speed controls for motors. Harmonic distortion causes significant currents at frequencies that are odd multiples of the power line frequency. Harmonic current can cause a substantial load on the neutral wires of wye-connected power distribution systems.

In most countries, 50Hz or 60Hz power distribution systems include 3-phase delta primary - wye secondary transformers. The secondary generally provides 120VAC from phase to neutral, and 208VAC from phase to phase. Historically, balancing the loads on each phase was a big headache for the electrical system designer.

Typically, the vector addition of the phase currents in the transformers' neutral wire is zero or quite low in a wellbalanced system. Typical devices that present linear loading include incandescent lighting and small motors. The result is essentially a sine wave current in each phase and a low neutral current at a frequency of 50Hz or 60Hz.

Devices such as TV sets, fluorescent lighting, video machines, and microwave ovens are now commonly drawing power line current for only a fraction of each cycle so that they cause non-linear loading and subsequent non-linear current. This generates odd harmonics of the 50Hz or 60Hz line frequency. Therefore, the current waveform from the transformer could contain not only a 60Hz component, but also a 180Hz component, a 300Hz component, etc.

The vector addition in a properly balanced power distribution system feeding non-linear loads may still be quite low. However, the vector addition does not cancel all the harmonic currents. The odd multiples of the 3rd harmonic (called the "TRIPLENS") are added together in the neutral. These harmonics can create an RMS current in the transformers neutral wire that is 130% of the total RMS current measured in any individual phase. For example, phase currents of 80 amperes may cause 104 amperes of harmonic current in the neutral, the most common harmonic being the 3rd. The electrical designer must consider the following issues when designing a power distribution system that will contain harmonic current.

1. The AC neutral wires must be of sufficient gauge to allow for harmonic current.
2. The distribution transformer must have additional cooling to continue operation at its rated capacity. This is because the harmonic current in the secondary neutral wire is circulating in the deltaconnected primary winding. This circulating harmonic current heats up the transformer.
3. Phase current harmonics are reflected to the primary winding and they continue back towards the power source. This can cause distortion of the voltage wave so that any power factor correction capacitors on the line can be easily overloaded.

We can use this Meter to analyze components such as power distribution transformers and power factor correction capacitors. An additional feature allows the measurement of half-cycle peak current by using the 1 ms peak hold feature. This allows the ability to determine crest factor:

$$\text{Crest factor} = \text{Peak value}/\text{True rms value}$$

NOTE: If Crest Factor exceeds 1.1, harmonic distortion is present

TRUE RMS MEASUREMENT

The meter measures the TRUE RMS value of AC voltages and currents. In physical terms, the RMS (Root-Mean-Square) value of a waveform is the equivalent DC value that causes the same amount of heat to be dissipated in a resistor. TRUE RMS measurement greatly simplifies the analysis of complex AC signals. Since the RMS value is the DC equivalent of the original waveform, it provides a reliable basis for comparing dissimilar waveforms.





By contrast, many meters use average-responding AC converters rather than TRUE RMS converters. The scale factor in these meters are adjusted so that they display the RMS value for a harmonic-free sine wave. If a signal is not sinusoidal, average-responding meters do not display correct RMS readings.

□ WAVEFORM COMPARISON

Table 3. illustrates the relationship between AC and DC components for common waveforms, and compares readings for TRUE RMS meters and average-responding meters. For example, consider the first waveform, a 141.4AV (zero-to-peak) sine wave. Both this Clamp-on meter and RMS-calibrated average-responding meters display the correct RMS reading of 100.0V(the DC component equals 0). However, consider the 200V(peak-to-peak) square wave, both types of meter correctly measure the DC component (0V). The clamp meter correctly measures the AC component (100.0V). The average-responding meter measures 111.1V, which amounts to an 11 %error.

The conversion factors in Table 3 show the differences between average sensing instrument measurements and true RMS instrument

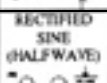
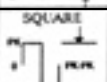
Table 3. WAVEFORM COMPARISON CHART

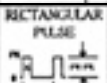
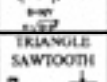
AC-COUPLED INPUT WAVEFORM	PEAK VOLTAGE		METERED VOLTAGES			DC AND AC TOTAL RMS
	PK-PK	0-PK	AC COMPONENT ONLY RMS CAL	DC COMPONENT OUR METER	DC COMPONENT ONLY	TRUE RMS= ac ² +dc ²
SINE 	282.8	141.4	100.0	100.0	000.0	100.0
RECTIFIED SINE (FULL WAVE) 	141.4	141.4	042.1	043.6	090.0	100.0
RECTIFIED SINE (HALF WAVE) 	200.0	200.0	077.9	077.1	063.6	100.0
SQUARE 	200.0	100.0	111.1	100.0	000.0	100.0
RECTIFIED SQUARE 	141.4	141.4	087.5	070.7	070.7	100.0
RECTANGULAR PULSE 	200.0	200.0	444.2K ²	200K	200D	200 \sqrt{D}
TRIANGLE SAWTOOTH 	346.4	173.2	096.2	100.0	000.0	100.0

* RMS CAL IS THE DISPLAYED VALUE FOR AVERAGE RESPONDING METERS THAT ARE CALIBRATED TO DISPLAY RMS FOR SINE WAVES

MAINTENANCE

WARNING

TO AVOID ELECTRICAL SHOCK, DO NOT PERFORM ANY SERVICING UNLESS YOU ARE QUALIFIED TO DO SO.

SERVICE

If the instrument fails to operate, check battery, test leads, etc. and replace as necessary. If the instrument still does not operate, double check operating procedure as described in this instruction manual. When servicing, use only specified replacement parts.

WARNING

TO AVOID ELECTRICAL SHOCK OR DAMAGE TO THE METER, DO NOT GET WATER INSIDE THE CASE. REMOVE THE TEST LEADS AND ANY INPUT SIGNALS BEFORE OPENING THE CASE.

BATTERY REPLACEMENT

The meter is powered by a single 9V battery, with NEDA1604, S006P, IEC6F22 carbon-zinc alkaline, or similar battery. Replace battery if the low battery sign (⚡) is displayed and flashing. Use the following procedure to replace the battery:

1. Remove the meter from the circuit and turn the rotary switch to the OFF position.
2. Disconnect the test leads from the instrument.
3. Loosen the screw on the battery cover.
4. Pull the cover up slightly and slide the battery cover off (see Figure 24 and Figure 25).
5. Replace the defective battery.
6. Reverse the procedure of opening cover to close the battery cover.

CLEANING

To clean the instrument, use a soft cloth dampened in a solution of mild detergent and water. Do not spray cleaner directly onto the instrument, since it may leak into the cabinet and cause damage.

Do not use chemicals containing benzene, toluene, xylene, acetone or similar solvents.

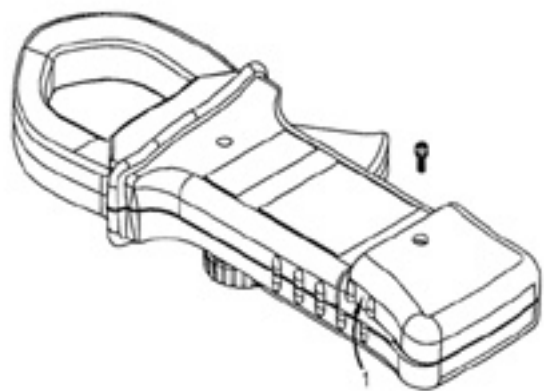

Pull up slightly.

Figure 22. Step 1 of Battery Replacement.

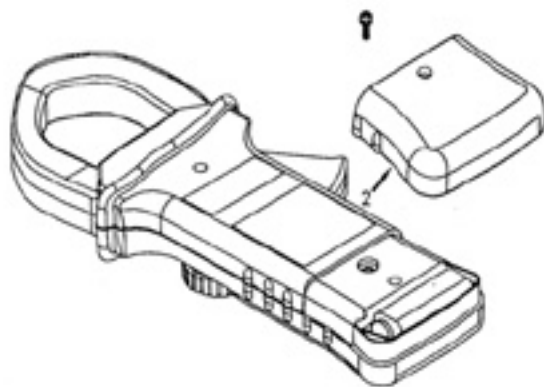

Figure 24. Step 2 of Battery Replacement.